







# The range needed for the right peritoneal access

Explore the Argyle™\*  
Peritoneal Dialysis  
Catheter portfolio



Different patients have different anatomies and needs, so why settle for a less than ideal fit? With Argyle™\* peritoneal dialysis catheters, you don't have to. Our variety of configurations and lengths gives you options designed to support long-term access preservation and patency.

Available Peritoneal Components		
Internal end	 Straight	 Coiled
Fixation components	 1 cuff	 2 cuff
Transmural segment	 Straight	 Pre-formed bend

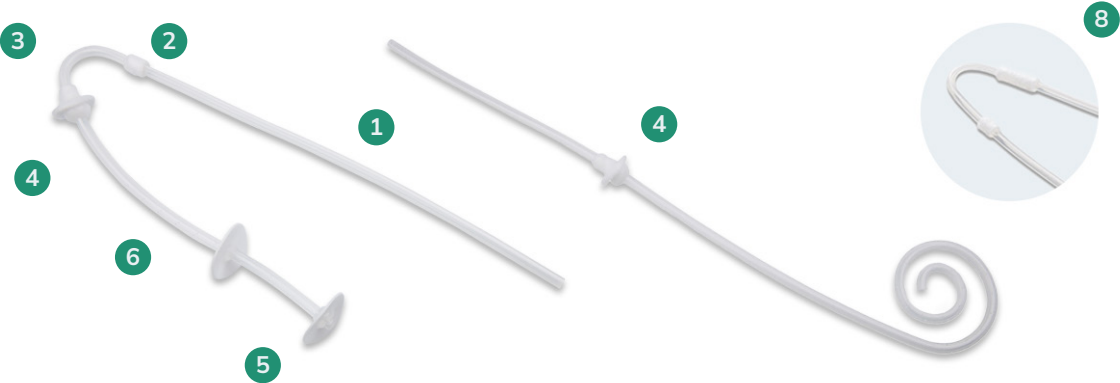

1. Radiopaque Silicone  
Identify under x-ray.

2. Felt Cuff

3. Bend  
Swan neck options.

4. Missouri Bead + Felt Cuff

5. Oreopoulos-Zellerman  
Option with two silicon disks.

6. Straight (Tenckhoff)  
Indwelling portion of catheter.

7. Curled  
Indwelling portion of catheter.

8. Moncrief-Popovich

# Our complete peritoneal access portfolio

Peritoneal Access products can be ordered in either a catheter configuration or a catheter kit configuration.

## Catheter Configuration Includes:

Sterile contents included in the kit

- (1) Peritoneal Catheter
- (1) Beta-Cap Adapter
- (1) Beta-Cap Clamp

When ordering a single catheter, you may also purchase these accessories:

## SINGLE CATHETER ACCESSORIES:

### 16 Fr Pull-Apart Introducer Set

Code	Includes	Ship Case
8815544010  † Made with PolyTetra FluoroEthylene (PTFE)	(1) 16 Fr Pull-Apart Sheath/Dilator	5
	(1) 18 ga Introducer Needle	
	(1) 12 mL Syringe	
	(1) J/Straight 0.038" Guide Wire	

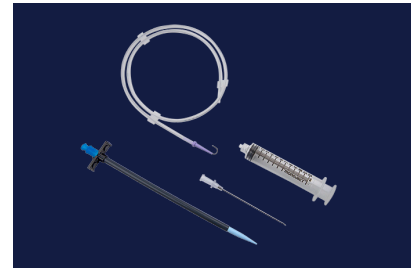

### Tunneling Stylet, sterile, single use (choose one tunneling stylet per catheter)

Code	Description	Ship Case
8817791001	Atraumatic Peritoneal Tunneling Stylet	5
8888415679	Faller Tunneling Stylet	1

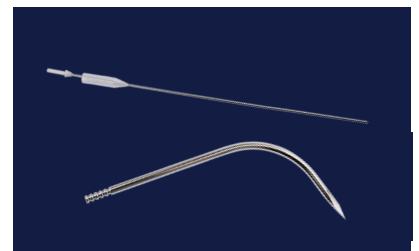

### Straightening Stylet, Non-sterile, Autoclavable

Code	Description	Ship Case
8888415661	Insertion/Straightening Stylet, 61 cm	1

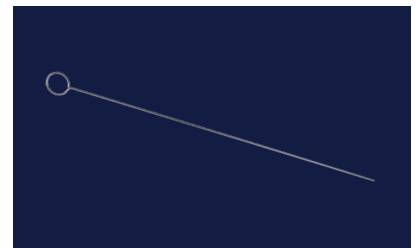

### Catheter Kit Configuration Includes:

#### Sterile contents included in the kit

- (1) Peritoneal Catheter
- (1) Beta-Cap Adapter, Cap and Clamp
- (1) 16 Fr Pull-Apart Sheath†/Dilator
- (1) 18 ga Introducer Needle
- (1) J/Straight Guide Wire
- (1) 12 mL Syringe
- (1) #11 Scalpel
- (1) Atraumatic Peritoneal Tunneling Stylet
- (1) 4" × 4" Gauze Sponges

† Made with PolyTetra FluoroEthylene (PTFE)

When ordering a catheter kit, you may also purchase this accessory:

### Catheter Kit Accessory:

#### Straightening Style, Non-sterile, Autoclavable (choose one stylet per catheter)

Code	Includes	Ship Case
8888415661	Insertion/Straightening Stylet, 61 cm	1

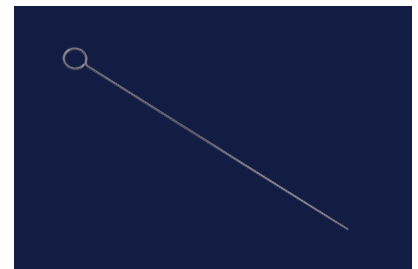

# Tenckhoff Peritoneal Catheters

## Argyle™\* Tenckhoff Peritoneal Catheters

Choose from a variety of catheter lengths and cuff placements and types, or choose the Argyle™\* Universal Tenckhoff catheter – a catheter that can be trimmed to fit most patient sizes. The Tenckhoff catheter is offered in the following cuff configurations:

- One attached cuff – in either the subcutaneous or preperitoneal position
- Two attached cuffs – one subcutaneous and one preperitoneal
- Two disks with one or two cuffs – Oreopoulos-Zellerman, Missouri catheter

### Tenckhoff Catheters - One Cuff

Type	Code	Description	Ship Case
Catheter	8814843001	Tenckhoff Catheter, 1 Preperitoneal Cuff, 41 cm	1

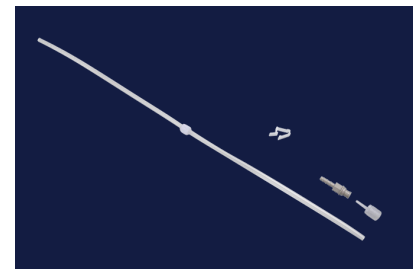
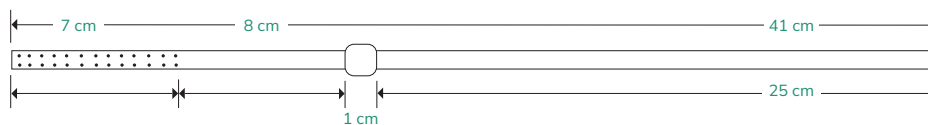

Type	Code	Description	Ship Case
Catheter	8810889003	Tenckhoff Catheter, 1 Subcutaneous Cuff, 42 cm	1

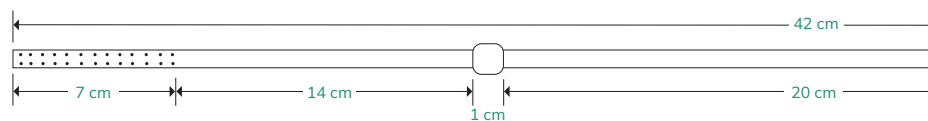

Type	Code	Description	Ship Case
Catheter	8814843002	Tenckhoff Catheter, Universal, 1 Preperitoneal Cuff, 46 cm	1
Kit	8817278001	Tenckhoff Catheter, Universal, 1 Preperitoneal Cuff Kit, 46 cm	5



## Tenckhoff Catheters - Two Cuffs

Type	Code	Description	Ship Case
Catheter	8888411405	Tenckhoff Catheter, 2 Cuffs, 41 cm	1

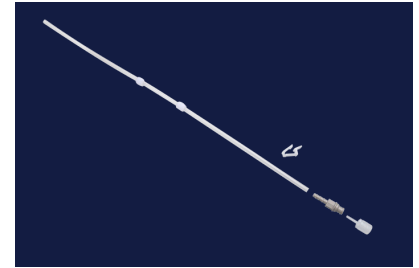
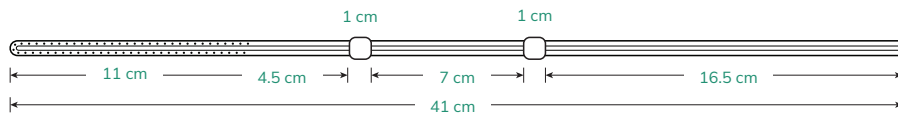

Type	Code	Description	Ship Case
Catheter	8810888003	Tenckhoff Catheter, 2 Cuffs, 42 cm	1
Kit	8817278008	Tenckhoff Catheter, 2 Cuffs Kit, 42 cm	5

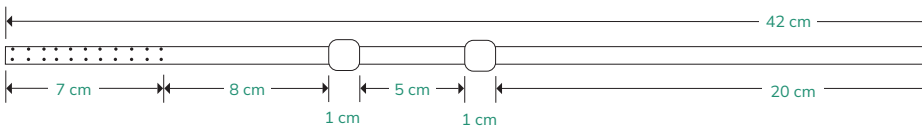

Type	Code	Description	Ship case
Catheter	8810888012	Tenckhoff Catheter, Universal, 2 Cuffs, 47 cm	1
Catheter	8888411447	Tenckhoff Catheter, 2 Cuffs, 47 cm	1

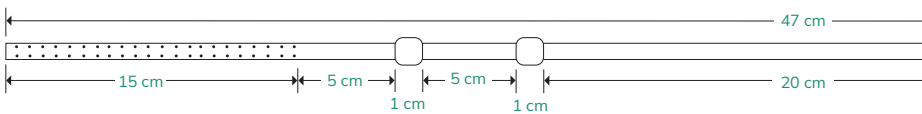

Type	Code	Description	Ship Case
Catheter	8810887003	Tenckhoff Catheter, 2 Mobile Cuffs, 42 cm	1

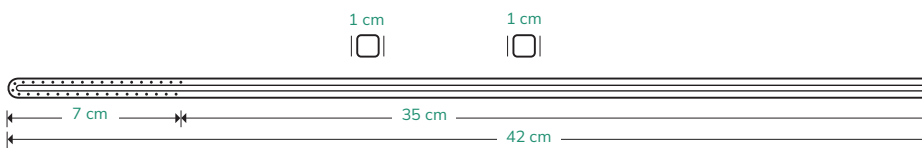

## Oreopoulos-Zellerman Missouri Catheters

Type	Code	Description	Ship Case
Catheter	8888411009	Oreopoulos-Zellerman Catheter, Missouri Catheter 1 Bead, 2 Disks, 2 Cuffs, 41 cm	1

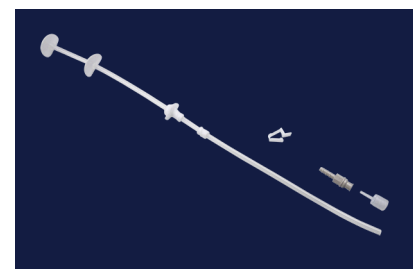
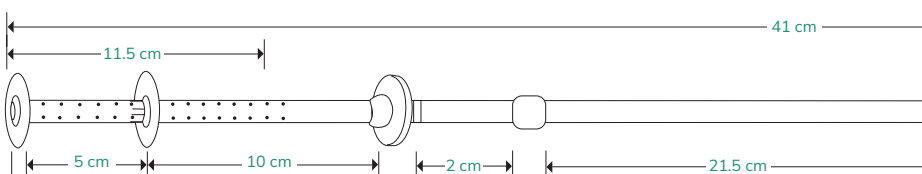

# Swan Neck Peritoneal Catheters

## Argyle™\* Swan Neck Peritoneal Catheters

Choose from a variety of catheter options: Tenckhoff, Curl Cath, Missouri, Oreopoulos-Zellerman and Presternal. Paediatric catheters are also available.

- The Swan Neck catheter employs a pre-formed angle.
- The felt cuffs anchor the catheter subcutaneously.
- A radiopaque stripe on the front of each catheter makes it visible to differentiate under x-ray.
- Stencils are available for skin markings prior to surgery. Each stencil reflects the exact shape of the catheter.

## Swan Neck Tenckhoff Catheters

Swan Neck Tenckhoff catheter is a standard Tenckhoff with a pre-formed angle.

Type	Code	Description	Ship Case
Catheter	8888412007	Swan Neck Tenckhoff Catheter, 2 Cuffs, Left, 43 cm	1
Catheter	8888425728	Swan Neck Tenckhoff Catheter, 2 Cuffs, Left, 48 cm	1

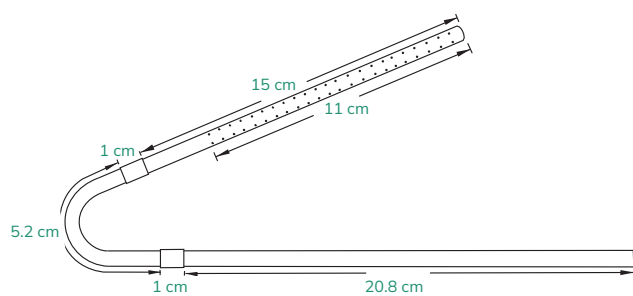
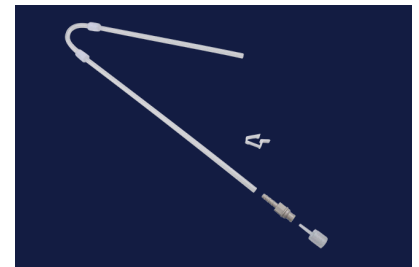

Type	Code	Description	Ship Case
Catheter	8888412015	Swan Neck Tenckhoff Catheter, 2 Cuffs, Right, 43 cm	1

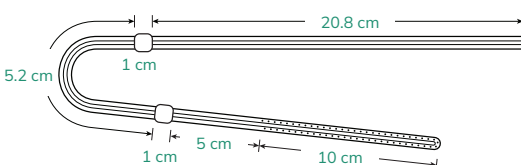

## Swan Neck Curl Cath Catheters

Swan Neck Curl Cath catheter employs the weight of the curl and the pre-formed bend. The outside portion of the catheter is positioned downward.

Type	Code	Description	Ship Case
Catheter	8888413807	Swan Neck Curl Cath Catheter, 2 Cuffs, Left, 62.5 cm	1
Kit	8888413823	Swan Neck Curl Cath Catheter Kit, 2 Cuffs, Left, 62.5 cm	1

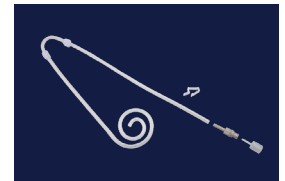

Type	Code	Description	Ship Case
Catheter	8888413815	Swan Neck Curl Cath Catheter, 2 Cuffs, Right, 62.5 cm	1
Kit	8888413831	Swan Neck Curl Cath Catheter Kit, 2 Cuffs, Right, 62.5 cm	1

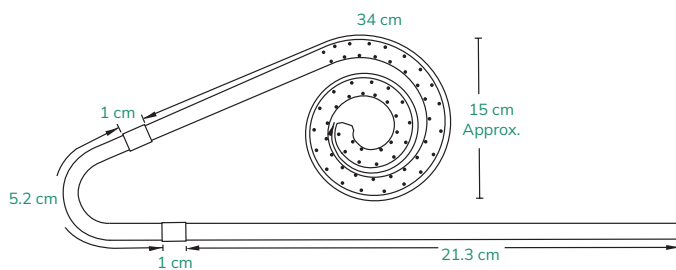

## Swan Neck Oreopoulos-Zellerman Catheters

The Swan Neck Oreopoulos-Zellerman (also called Toronto Western) Catheter is available in Tenckhoff and Missouri configurations. These catheters are differentiated from other Swan Neck catheters by the two silicone discs added to the internal catheter segment.

Type	Code	Description	Ship Case
Catheter	8888413005	Swan Neck Oreopoulos-Zellerman Catheter, 2 Cuffs, Left, 44.5 cm	1
Catheter	8888413013	Swan Neck Oreopoulos-Zellerman Catheter, 2 Cuffs, Right, 44.5 cm	1

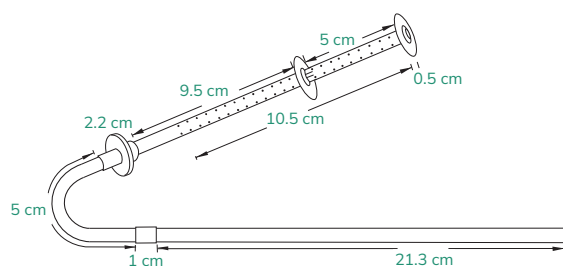
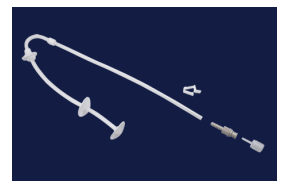



## Swan Neck Missouri Catheters

The Swan Neck Missouri Catheter is the same basic design as the Swan Neck Tenckhoff and Curl Cath catheters with the addition of a silicone bead and a felt disk.

Type	Code	Description	Ship Case
Catheter	8888412601	Swan Neck Missouri Catheter, 2 Cuffs, Left, 44.5 cm	1
Catheter	8888412619	Swan Neck Missouri Catheter, 2 Cuffs, Right, 44.5 cm	1

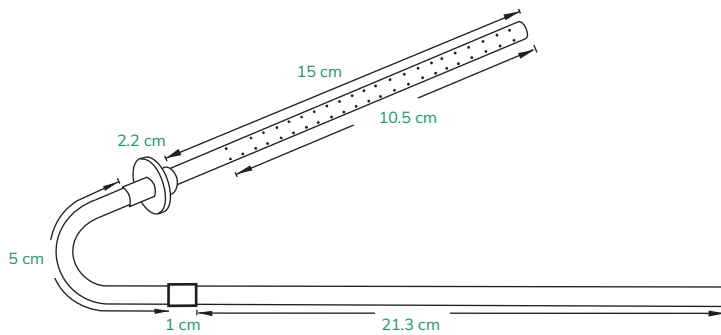
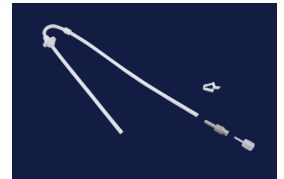

Type	Code	Description	Ship Case
Catheter	8888413401	Swan Neck Curl Cath Missouri Catheter, 2 Cuffs, Left, 62.5cm	1
Catheter	8888413419	Swan Neck Curl Cath Missouri Catheter, 2 Cuffs, Right, 62.5cm	1

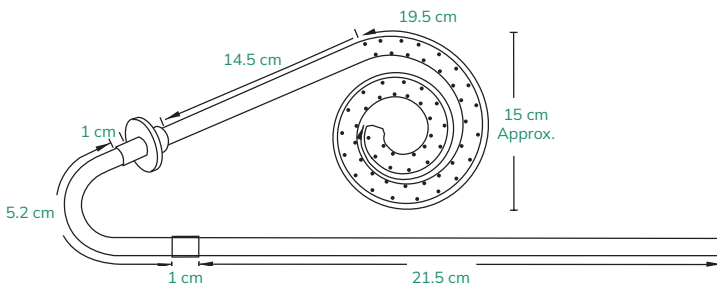
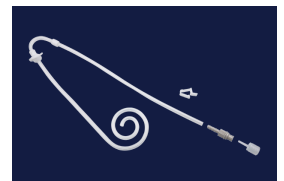

## Moncrief-Popovich Swan Neck Curl Cath Catheter

Type	Code	Description	Ship Case
Catheter	8888414029	Moncrief-Popovich Swan Neck Curl Cath Catheter, 2 Cuffs, 62.5 cm	5

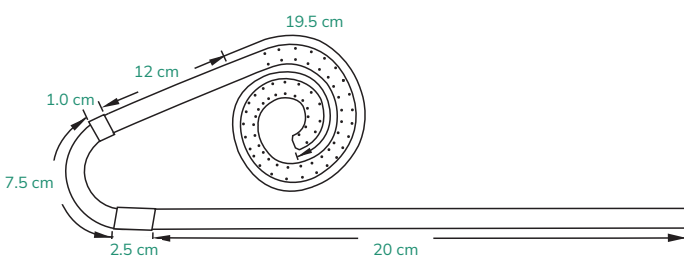

## Swan Neck Presternal Catheter

**Description of Components:** The presteral (upper) segment of this catheter is tunneled into the subcutaneous tissue of the chest wall. The upper segment connects with the intraperitoneal (lower) segment by a double-barbed titanium connector. Both the presteral and intraperitoneal segments can be trimmed in order to custom fit the patient. The intraperitoneal segment is a variation of the Missouri catheter:

Type	Code	Description	Ship Case
Catheter	8888414011	Swan Neck Presternal Catheter, 2 Cuffs, 112.8 cm (Swan Neck: 60.3 cm + 52 cm Curl)	1

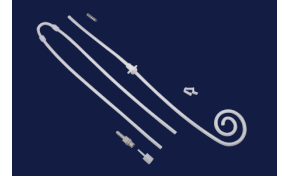

### Assembled Presternal Catheter

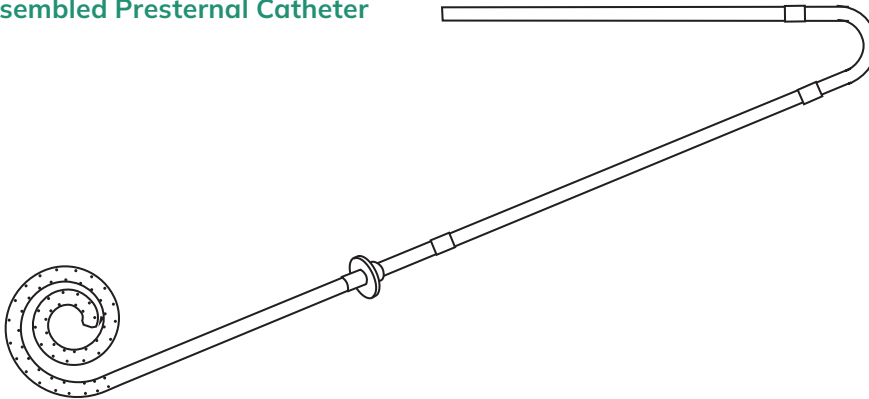

### Presternal Upper Segment 60.3 cm

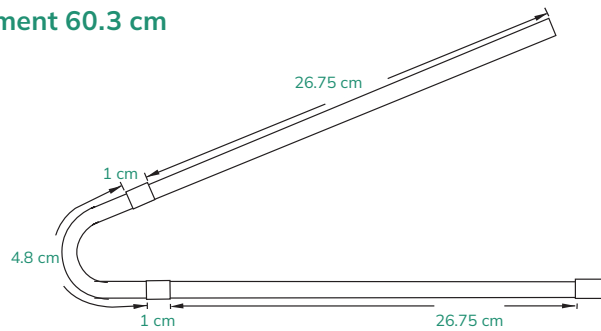

### Intraperitoneal Lower Segment 52 cm

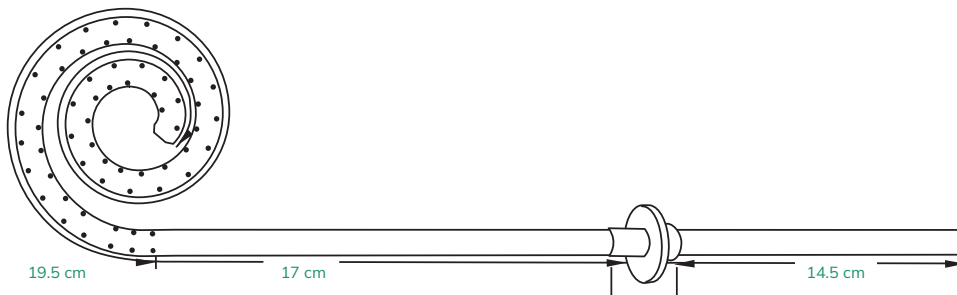

# Curl Cath Peritoneal Catheters

## Argyle™\* Curl Cath Peritoneal Catheters

### Features

The Curl Cath catheter, a modified Tenckhoff catheter, is suitable for acute or chronic peritoneal dialysis. It can be inserted either percutaneously or surgically.

The Curl Cath catheter is made of translucent, medical-grade silicone rubber with a radiopaque stripe. It has a 4.9 mm O.D., and a 2.6 mm I.D., and comes in adult or paediatric lengths. Unlike polyurethane catheters, the Curl Cath can be extended or repaired if necessary, eliminating the need for costly catheter replacement due to external damage.

Felt cuffs anchor the catheter subcutaneously. To meet the varying needs of patient and physician, two cuff configurations are offered:

- One attached cuff – in the preperitoneal position
- Two attached cuffs – one subcutaneous and one preperitoneal

The Ultem™\*† adapter included in the packaging provides a tight closure with standard CAPD transfer sets. Titanium adapters are also available.

Titanium adapters are also available.

† Made with PolyTetra FluoroEthylene (PTFE)

### Product Highlights

- Curled tubing with numerous inflow/outflow holes
- Can be inserted percutaneously or surgically
- Made of translucent, medical-grade silicone rubber
- Radiopaque stripe
- Can be extended or repaired if necessary
- Sterile

### Curl Cath Catheters – One Cuff

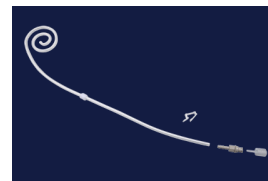
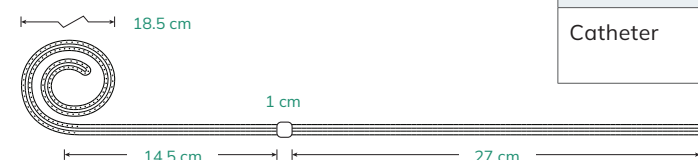
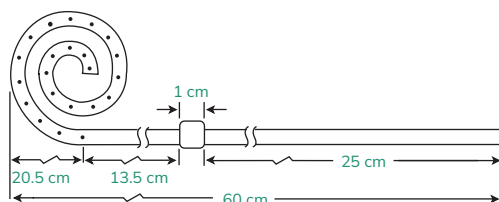
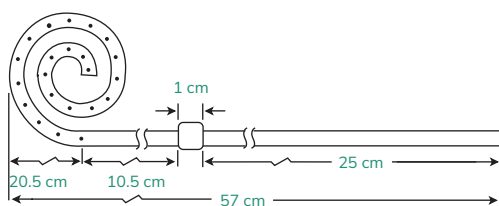

Type	Code	Description	Ship Case
Catheter	8811313014	Curled Catheter, 1 Cuff, 57 cm	1

Type	Code	Description	Ship Case
Catheter	8811313013	Curled Catheter, 1 Cuff, 60 cm	1
Kit	8817278010	Curled Catheter, 1 Cuff Kit, 60 cm	5

Type	Code	Description	Ship case
Catheter	8888425702	Oreopoulos-Zellerman Curled Catheter 1 Cuff, 63cm	1

## Curl Cath Catheters – Two Cuffs

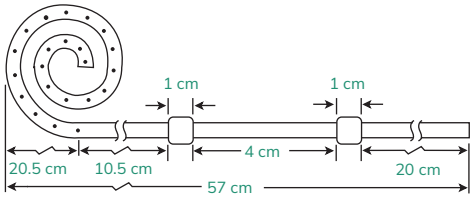
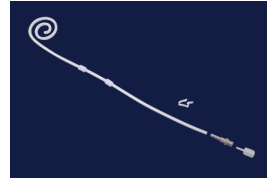

Type	Code	Description	Ship Case
Catheter	8811313015	Curled Catheter, 2 Cuffs, 57 cm	1
Kit	8817278007	Curled Catheter, 2 Cuffs Kit, 57 cm	5

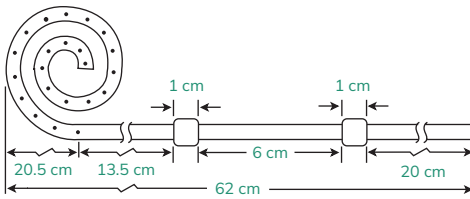

Type	Code	Description	Ship Case
Catheter	8811313010	Curled Catheter, 2 Cuffs, 62 cm	1
Catheter	8888411702	Curled Catheter 2 Cuffs, 62 cm	1
Kit	8817278006	Curled Catheter, 2 Cuffs Kit, 62 cm	5

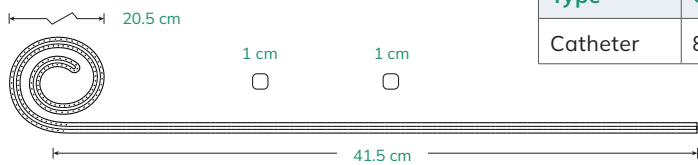

Type	Code	Description	Ship Case
Catheter	8811313009	Curled Catheter, 2 Mobile Cuffs, 62 cm	1

Type	Code	Description	Ship Case
Catheter	8888425710	Oreopoulos-Zellerman Curled Catheter 2 cuffs, 1 bubble 62 cm	1

# Paediatric Peritoneal Catheters

## Paediatric Tenckhoff Catheters

Type	Code	Description	Ship Case
Catheter	8888414219	Paediatric Tenckhoff, 1 Cuff, 30 cm	1

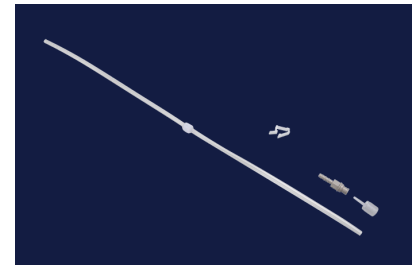
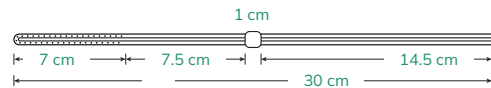

Type	Code	Description	Ship Case
Catheter	8812329001	Neonatal Tenckhoff, 1 Subcutaneous Cuff, 31 cm	1

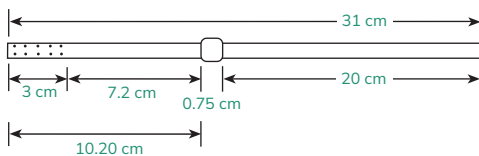

Type	Code	Description	Ship Case
Catheter	8812321001	Paediatric Tenckhoff, 1 Subcutaneous Cuff, 37 cm	1

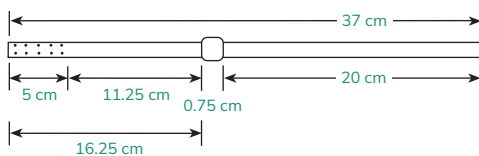

Type	Code	Description	Ship Case
Catheter	8888414201	Paediatric Tenckhoff, 2 Cuffs, 30 cm	1

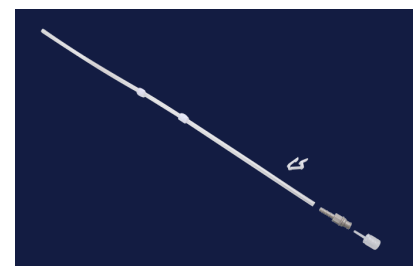
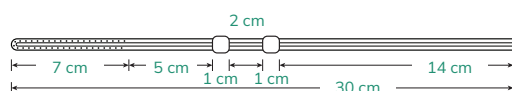

Type	Code	Description	Ship Case
Catheter	8812329002	Neonatal Tenckhoff, 2 Cuffs, 31 cm	1

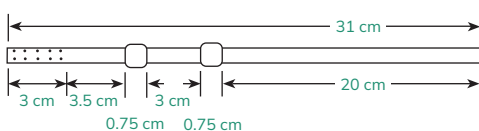

Type	Code	Description	Ship Case
Catheter	8888414227	Neonatal Tenckhoff, 2 Cuffs, 31 cm	1
Catheter	8810890014	Paediatric Tenckhoff, 2 Cuffs, 32 cm	1

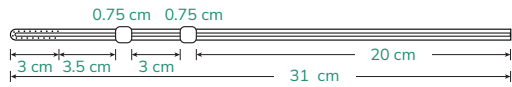

Type	Code	Description	Ship Case
Catheter	8810890003	Paediatric Tenckhoff, 2 Cuffs, 37 cm	1

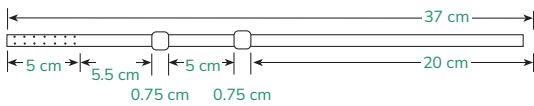

### Paediatric Curl Cath Catheter

Type	Code	Description	Ship Case
Catheter	8815677001	Paediatric Curl Cath Catheter, 1 Cuff, 39 cm	1

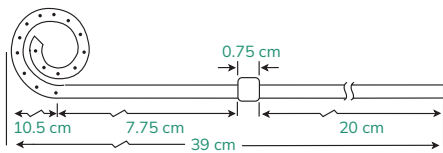

### Paediatric Tenckhoff Swan Neck Catheter

Type	Code	Description	Ship Case
Catheter	8888410506	Paediatric Swan Neck Tenckhoff Catheter, 2 Cuffs, Left, 37.5 cm	1

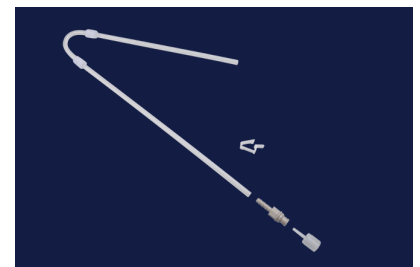
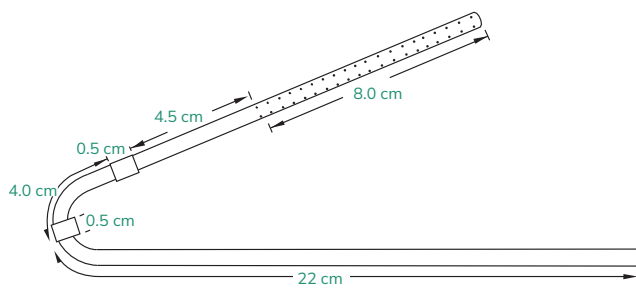

### Paediatric Swan Neck Curl Cath Catheters

Type	Code	Description	Ship Case
Catheter	8888413100	Infant Swan Neck Curl Cath Catheter, 2 Cuffs, 38.9 cm	1

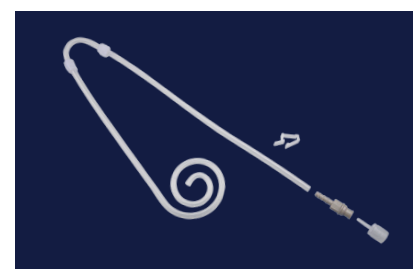
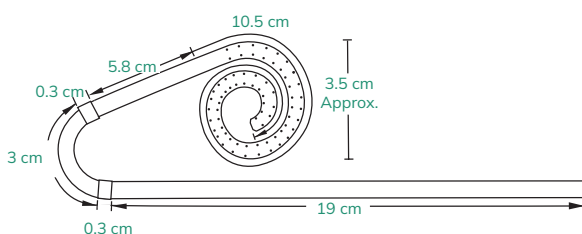

Type	Code	Description	Ship Case
Catheter	8888414813	Paediatric Swan Neck Curl Cath Catheter, 2 Cuffs, Left, 42 cm	1

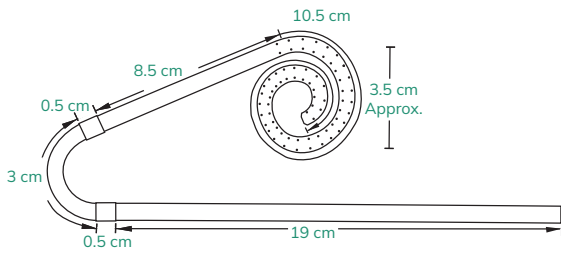

Type	Code	Description	Ship Case
Catheter	8888413101	Paediatric Swan Neck Curl Cath Catheter, 2 Cuffs, 43 cm	1

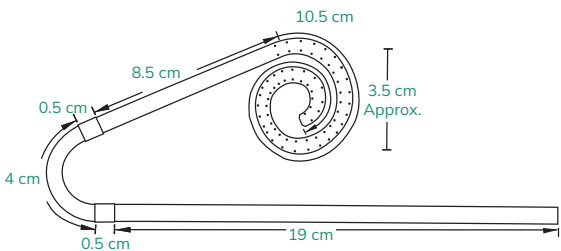

Type	Code	Description	Ship Case
Catheter	8888413102	Adolescent Swan Neck Curl Cath Catheter, 2 Cuffs, 59 cm	1

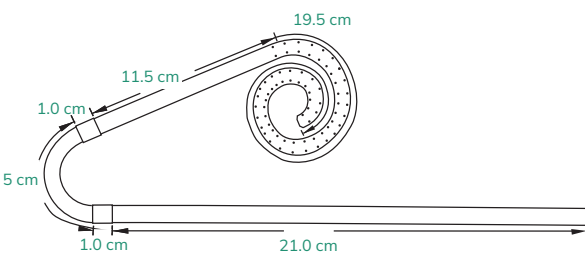

### Paediatric Swan Neck Curl Cath Missouri Catheter

Type	Code	Description	Ship Case
Catheter	8888415307	Paediatric Swan Neck Curl Cath Missouri Catheter, 2 Cuffs, Left, 42 cm	1

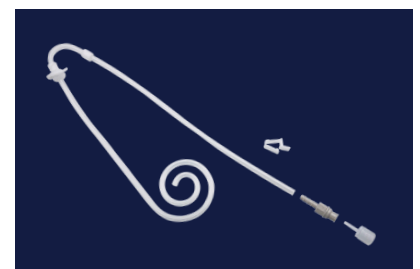
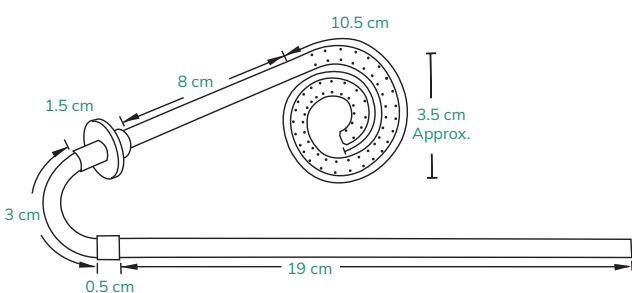

# Accessories For Peritoneal Catheters

## Peritoneal Catheter Straightening Stylet

Keeps the catheter straight for maneuvering during insertion into the peritoneum. The stylet can be used on all catheter types. Non-sterile. Autoclavable.

Code	Description	Ship Case
8888415661	Insertion/Straightening Stylet, 61 cm, for use with catheters 61 cm or shorter	1



## Atraumatic Peritoneal Tunneling Stylet

This atraumatic tunneling stylet penetrates tissue cleanly. As the stylet dilates the tissue, the practitioner simultaneously pulls the catheter through the tunnel. Made of pliable stainless steel, it can be bent to create a customized, curved tunnel. Sterile, single use. The stylet is 5 Fr x 23 cm (9").

Code	Description	Ship Case
8817791001	Atraumatic Peritoneal Tunneling Stylet	5



## Faller Tunneling Stylet

This stylet is an alternative to the atraumatic tunneling stylet. It has a cutting edge on the portion leading into the tunnel and a barbed portion on the opposite end which connects to the catheter. Sterile, single use.

Code	Description	Ship Case
8888415679	Faller Tunneling Stylet	1



## Titanium Adapter

An alternative to the Beta-Cap Adapter. Can be used on all Argyle™\* peritoneal catheters.

Code	Description	Ship Case
8888415604	Titanium Two Part Adapter	1





## Argyle™\* Pull-Apart Introducer Set with PTFE

Sterile contents included in the kit:

- (1) 16 Fr Pull-Apart Sheath/Dilator†
- (1) 18 ga Introducer Needle
- (1) 12 mL Syringe
- (1) J/Straight 0.038" Guidewire

Code	Description	Ship Case
8815544010	16 Fr Pull-Apart Introducer Set†	5

† Made with PolyTetra FluoroEthylene (PTFE).



## Medical Grade Silicone Adhesive Type A

This sterile adhesive is used for:

- Bonding felt cuffs to the catheter
- Repairing damaged catheters
- Extending the length of existing catheters

Code	Description	Ship Case
8810807001	Medical Grade Silicone Adhesive Type A	1



## Injection Sealing Caps

Used to close off the end of any Argyle™\* Catheter. Universal luer fitting.

Code	Description	Ship Case
8813791001	Injection Sealing Cap	50



## Beta-Cap Adapter

These adapters form a tight closure with standard CAPD transfer sets, or connect to a sealing cap. The Beta-Cap adapter is made of Ultem™\* resin. Can be used with all Argyle™\* Peritoneal Catheters.

Code	Description	Ship Case
8814661001	Beta-Cap Adapter	25



## Beta-Cap Clamp

Used to clamp the peritoneal catheter tubing when not in use.

Code	Description	Ship Case
8810805001	Beta-Cap Clamp	25



## Catheter Extender

Provides 15.2 cm of silicone tubing with a titanium connector.

Code	Description	Ship Case
8888415612	Adult Titanium Catheter Extender	1



## Peri-Patch Repair Kit

Use an Argyle™\* Peritoneal Catheter Repair Kit to replace the external portion of a damaged catheter and eliminate the need for catheter replacement. Sterile.

**NOTE:** To repair an indwelling catheter there must be at least 3 cm of undamaged tubing at the exit site.

Code	Description	Ship Case
8888285001	Peri-Patch Repair Kit	1

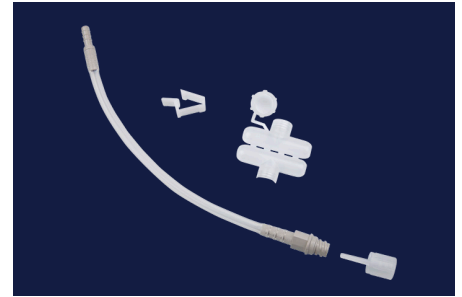

**NOTE:** Also order Medical Grade Silicone Adhesive using code # 8810807001.

### Sterile contents included in the kit:

- (1) 15 cm Silicone Rubber Catheter Extension (2.6 mm I.D., 4.9 mm O.D.)  
with Double-Barbed Connector
- (1) Beta-Cap Adapter, Cap and Clamp
- (1) Glue Mold



Mozarc Medical  
EMEA Regional Headquarters  
Via Varesina, 162  
20156 Milano MI, Italy

 [emeacontactus@mozarcmedical.com](mailto:emeacontactus@mozarcmedical.com)

 [mozarcmedical.com](https://www.mozarcmedical.com)

 LinkedIn

Copyright © 2024 Mozarc Medical Holding LLC.  
Mozarc, Mozarc Medical, the Mozarc Medical logos,  
and Empowering Patients. Enriching Lives.  
are trademarks of Mozarc Medical.

™\* Third-party brands are trademarks of their respective owners.  
\* Argyle™ is a trademark of Cardinal Health, Inc., used under license.

03/2024. EMEA-RC-2300063

Products may not be available in certain countries.

**Mozarc**  
Empowering patients.  
Enriching lives. **medical**