

# Explore our custom approach to peritoneal dialysis

Convenience and dependability come standard with our peritoneal dialysis catheter line



# Table of contents

<b>Catheter and catheter kit ordering guide</b> .....	3–5
<b>Tenckhoff peritoneal catheters</b>	
Tenckhoff peritoneal catheters .....	6
1 Cuff .....	6
2 Cuffs.....	7
Tenckhoff Missouri Oreopoulos-Zellerman catheters .....	7
<b>Swan neck specialty peritoneal catheters</b>	
Swan neck Tenckhoff catheters.....	8
Swan neck curl cath catheters .....	9
Swan neck Oreopoulos-Zellerman catheters .....	9
Swan neck Missouri catheters .....	10
Moncrief-Popovich swan neck curl cath catheters .....	10
Swan neck presternal catheters .....	11–12
<b>Curl cath catheters</b>	
Curl cath catheter .....	13
1 Cuff .....	14
2 Cuffs .....	14
<b>Neonatal and pediatric peritoneal catheters</b>	
Pediatric Tenckhoff catheters .....	15
Pediatric curl cath catheter .....	15
Pediatric swan neck Tenckhoff catheter .....	16
Pediatric swan neck curl cath catheter.....	16
<b>Accessories: peritoneal catheters</b> .....	17–19
<b>Indications for use</b> .....	20

# Catheter and catheter kit ordering guide

## peritoneal dialysis catheters

### **Individualizing placement for patient management**

Peritoneal dialysis catheters provide permanent access to the peritoneal cavity for patients to fill and drain their dialysate daily. Repetitive use makes it important to customize the catheter exit site to facilitate easy patient and caregiver management.

### **Maintaining long-term care**

Optimizing catheter placement and exit sites promotes proper maintenance and reduces potential complications — in ways difficult-to-manage catheters cannot. Our peritoneal dialysis catheter line includes a variety of configurations for patient customization.

# Catheter-only components

---

Our peritoneal dialysis catheters are made of latex free, medical grade silicone rubber with a radiopaque stripe. These catheters are translucent, with a 4.9 mm outer diameter (OD) and a 2.6 mm inner diameter (ID).

Unlike polyurethane catheters, our peritoneal dialysis catheters can be extended or repaired if necessary, minimizing the need for costly catheter replacement caused by external damage.

## Components in catheter-only orders include:

- (1) Peritoneal catheter
- (1) Beta-Cap™ adapter
- (1) Beta-Cap™ clamp

When ordering a single catheter, you may also need the following procedural items:

(see page 17 for the full list of catheter accessories and ordering codes):

## Accessories:

- Pull Apart Introducer Set for Inserting Catheters and Pacing Leads, 16Fr (sheath/dilator)†
- Blunt tunneling stylet
- Faller tunneling trocar
- Catheter straightening stylet, 61 cm
- Peritoneal Dialysis Catheter Stencil, Swan Neck Tenckhoff
- Peritoneal Dialysis Catheter Stencil, Swan Neck Missouri

†Made with PolyTetra FluoroEthylene (PTFE)

# Catheter kit components

---

## Components included in catheter kits:

- (1) Peritoneal catheter
- 16Fr/Ch pull-apart introducer (sheath/dilator)<sup>†</sup>
- 18G introducer needle
- 12mL syringe
- J/straight guidewire
- Tunneling stylet
- #11 scalpel
- Gauze sponges
- Beta- Cap™ adapter, cap and clamp
- Instructions

## Harnessing convenience and cost efficiencies

Peritoneal dialysis catheter kits simplify inventory and save staff time when assembling supplies needed for catheter insertion.

## Recommended for percutaneous placement of the catheter.

The peritoneal catheter kit provides an alternative to catheter placement by laparotomy. Each kit features a 16Fr pull-apart introducer<sup>†</sup> used to insert the catheter percutaneously using the modified Seldinger technique. This technique uses a smaller incision — helping minimize the risk of postoperative dialysate leakage.<sup>1</sup>

<sup>†</sup>Made with PolyTetra FluoroEthylene (PTFE)

## Catheter kit accessories

When ordering a catheter kit, you may also need the following procedural items:

(see page 17 for accessories list and order codes)

- Catheter straightening stylet (available in 61 cm)
- Peritoneal Dialysis Catheter Stencil, Swan Neck Tenckhoff
- Peritoneal Dialysis Catheter Stencil, Swan Neck Missouri

# Tenckhoff peritoneal catheters

## Recommended for peritoneal dialysis or intraperitoneal chemotherapy

### Broadening your selection

Choose from a variety of catheter types, lengths and cuff placements. Or choose the universal Tenckhoff catheter, which can be trimmed to custom fit most patient sizes.

The Tenckhoff catheter comes in the following cuff configurations:

- One attached cuff — in either the subcutaneous or preperitoneal position.
- Two attached cuffs — one subcutaneous and one preperitoneal.
- Two disks with one or two cuffs — Oreopoulos-Zellerman, Missouri catheter style.

### Driving cost efficiencies to serve more patients

For your convenience, Tenckhoff catheters are packaged one per carton, enabling you to stock multiple configurations. Catheters are also available in time-saving, cost-efficient kits. They contain the basic items needed for percutaneous insertion, featuring the pull-apart introducer sheath/dilator and tunneling stylet.

### Delivering a complete system

Each Tenckhoff catheter comes with an adapter, cap, and clamp. The Beta-cap™ adapter forms a closure with standard CAPD transfer sets.

### Tenckhoff catheters: 1 cuff

Catheter 8814843001 Tenckhoff, 1 preperitoneal cuff, 41 cm 1/case

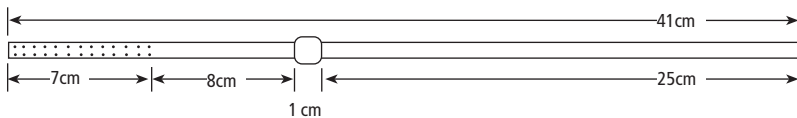

Catheter 8810889003 Tenckhoff, 1 subcutaneous cuff, 42 cm 1/case

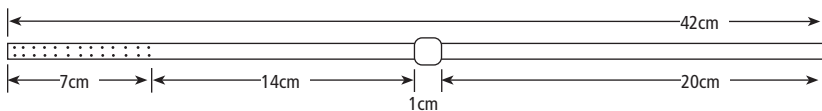

Catheter 8814843002 Universal Tenckhoff, 1 Preperitoneal Cuff, 46 cm 1/case

Kit 8817278001 Universal Tenckhoff, 1 Preperitoneal Cuff, 46 cm — catheter kit 5/case

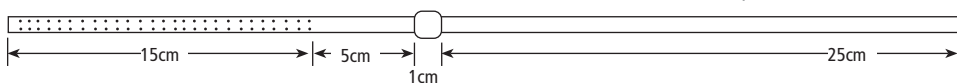

# Tenckhoff peritoneal catheters

## Tenckhoff catheters: 2 cuffs

Catheter	8810888003	Tenckhoff, 2 cuff, 42 cm	1/case
Kit	8817278008	Tenckhoff, 2 cuff, 42 cm — catheter kit	5/case

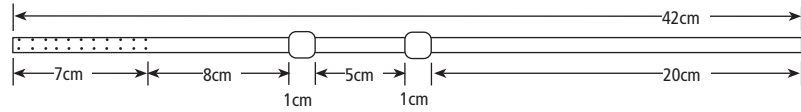

Catheter	8810888012	Universal Tenckhoff, 2 Cuff, 47 cm	1/case
----------	------------	------------------------------------	--------

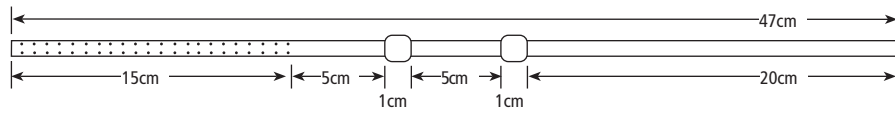

## Tenckhoff Missouri Oreopoulos-Zellerman catheters:

Catheter	8888411009	Tenckhoff, Missouri Oreopoulos-Zellerman, 2 Cuffs, 2 Disks, 1 Bead, 41 cm	1/case
----------	------------	---	--------

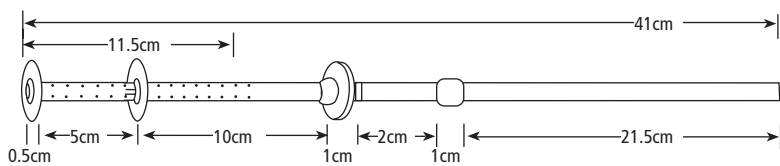

# Swan neck specialty peritoneal catheters

## Simplifying peritoneal dialysis access with options and features

The swan neck catheter employs a preformed angle and integrates felt cuffs to anchor the catheter subcutaneously.

## Choosing options for patient-specific needs

Swan neck catheters come in a variety of options:

- Tenckhoff
- Curl cath
- Missouri
- Oreopoulos-Zellerman
- Presternal
- Moncrief-Popovich
- Pediatric catheters are also available

## Visualizing preferred placement

A radiopaque stripe on the front of each catheter makes it viewable to differentiate under X-ray.

Stencils are available for skin markings before surgery. Each stencil reflects the exact shape of the catheter and is critical for proper catheter implantation.

## Swan neck Tenckhoff catheters

The swan neck Tenckhoff catheter is a standard Tenckhoff with a preformed angle.

Catheter 8888412007 Swan neck Tenckhoff, 2 cuff, left, 43 cm

1/case

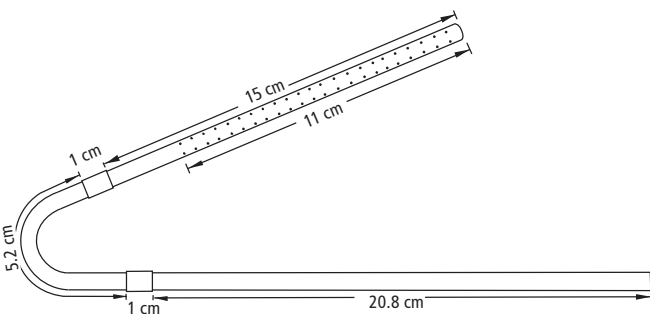

# Swan neck specialty peritoneal catheters

## Swan neck curl cath catheters

Swan neck curl cath catheter employs the weight of the curl and a preformed bend allows the outside portion of the catheter to be positioned downward.

Catheter	8888413101	Swan neck curl cath, 2 cuff, 43 cm	1/case
Catheter	8888413102	Swan neck curl cath, 2 cuff, 59 cm	1/case
Catheter	8888413807	Swan neck curl cath, 2 cuff, left, 62.5 cm	1/case
Catheter	8888414813	Swan neck curl cath, 2 cuff, left, 42 cm	1/case
Kit	8888413823	Swan neck curl cath, 2 cuff, left, 62.5 cm — catheter kit	1/case
Catheter	8888413815	Swan neck curl cath, 2 cuff, right, 62.5 cm	1/case
Kit	8888413831	Swan neck curl cath, 2 cuff, right, 62.5 cm — catheter kit	1/case

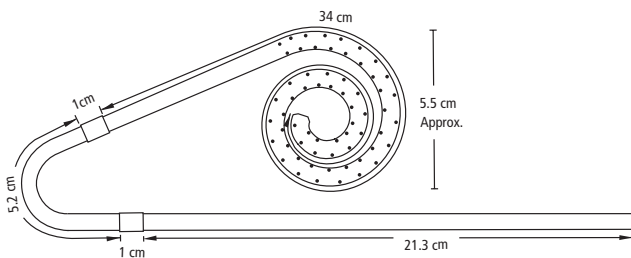

## Swan neck Oreopoulos-Zellerman catheters

The swan neck Oreopoulos-Zellerman (also called Toronto Western) catheter is available in Tenckhoff and Missouri configurations.

These catheters are differentiated from other swan neck catheters by the two silicone disks added to the internal catheter segment.

Catheter	8888413005	Swan neck Oreopoulos-Zellerman, 2 cuff, left, 44.5 cm	1/case
Catheter	8888413013	Swan neck Oreopoulos-Zellerman, 2 cuff, right, 44.5 cm	1/case

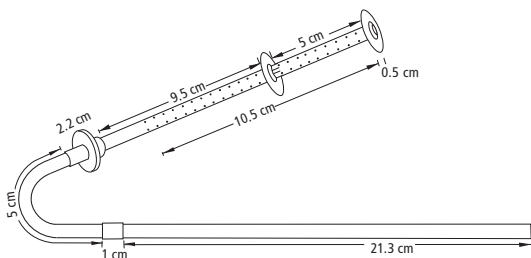

# Swan neck specialty peritoneal catheters

## Swan neck Missouri catheters

The swan neck Missouri catheter is the same basic design as the swan neck Tenckhoff and curl cath catheters with the addition of a silicone bead and a felt disk. The felt disk is placed just outside the peritoneum and is sutured to the rectus muscle. Fibroblasts grow into the fibers of the felt cuff and anchor the catheter. A second cuff in the subcutaneous tissue helps to seal the exit site.

Catheter	8888412601	Swan neck Missouri, 2 cuff, left, 44.5 cm	1/case
Catheter	8888412619	Swan neck Missouri, 2 cuff, right, 44.5 cm	1/case

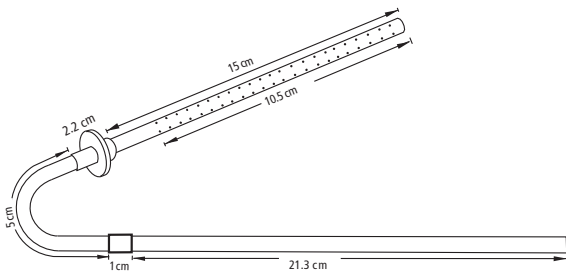

Catheter	8888413401	Swan neck curl cath Missouri, 2 cuff, left, 62.5 cm	1/case
Catheter	8888413419	Swan neck curl cath Missouri, 2 cuff, right, 62.5 cm	1/case

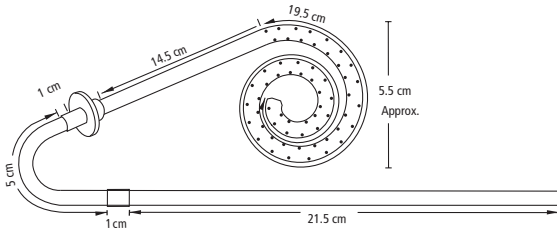

Catheter	8888415307	Swan neck Missouri curl cath, 2 cuff, left, 42.5 cm	1/case
----------	------------	---	--------

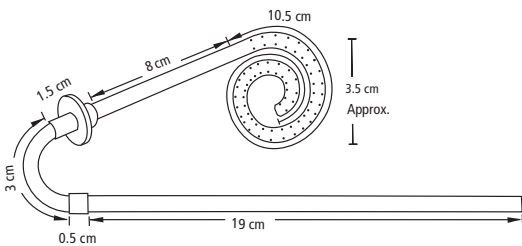

## Moncrief-Popovich swan neck curl cath catheters

Catheter	8888414029	Moncrief-Popovich Swan neck Curl Cath, 2 Cuff, 62.5 cm	5/case
----------	------------	--	--------

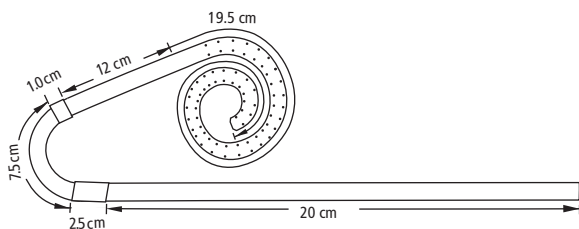

# Swan neck specialty peritoneal catheters

## Swan neck presternal catheters

This catheter comes in two sections (upper and lower segments). The presternal (upper) segment of this catheter is tunneled into the subcutaneous tissue of the chest wall. This upper segment connects with the intraperitoneal (lower) segment by a double-barbed titanium connector. Both the presternal and intraperitoneal segments can be trimmed to custom fit the patient. The intraperitoneal segment is a variation of the Missouri catheter.

As the exit site is located on the upper chest wall, instead of at the belt line, this catheter's presternal location may be supportive for:

- Certain patient lifestyle activities, such as wading in a pool or soaking in a tub
- Patients with obesity, who may have difficulty manipulating a catheter at the belt line
- Patients with urinary incontinence

### Assembled presternal catheter

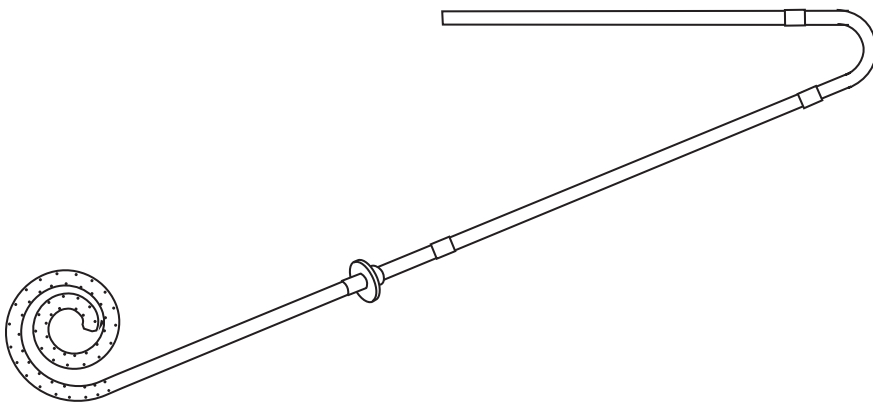

### Presternal lower segment

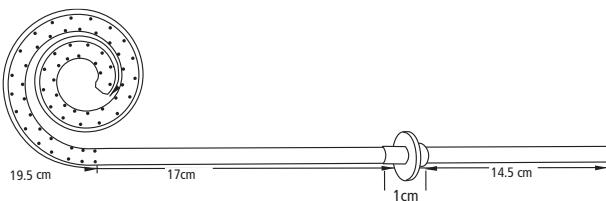

### Presternal upper segment 60.3 cm

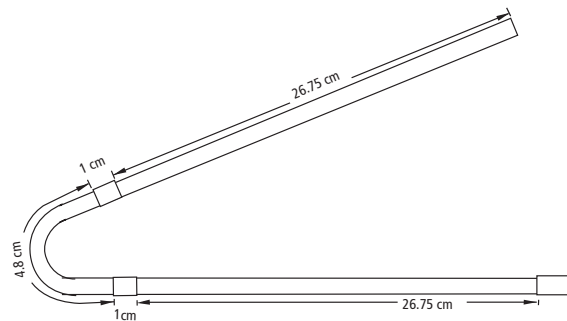

# Swan neck specialty peritoneal catheters

---

## Swan neck presternal catheters

### Intraperitoneal lower segment 52 cm

Catheter	8888414011	Presternal, Swan Neck, 2 cuff, 112.8 cm (Swan neck: 60.3 cm + 52 cm curl)	1/case
Tray	8888111132	Presternal, Swan Neck, curl cath, 1 cuff, 15 Fr, 122.3 cm	1/case
Kit	8888121132	Presternal, swan neck, curl cath, 1 cuff, 15 Fr, 122.3 cm — catheter kit	5/case

When ordering the swan neck presternal catheter kit, you may also need the following procedural items:

- Peritoneal Dialysis Catheter Stencil, Swan Neck Missouri
- Peritoneal Dialysis Catheter Stencil, Swan Neck Tenckhoff
- Faller tunneling trocar
- Catheter straightening stylet, 61 cm
- Two part titanium luer adapter

**Note:** See page 17 for the full list of catheter accessories and order codes.

# Curl cath catheters

---

Available in adult or pediatric lengths, the curl cath catheter is a modified Tenckhoff catheter, suitable for acute or chronic peritoneal dialysis. It can be inserted either percutaneously or surgically.

The additional mass of the curl cath catheter and numerous inflow/outflow holes diffuse dialysate into the patient.

## Featuring thoughtful materials and design

Felt cuffs anchor the catheter subcutaneously, helping to establish a natural tissue ingrowth barrier. To meet the varying needs of patient and physician, two cuff configurations are offered:

- One attached cuff in the preperitoneal position
- Two attached cuffs, one subcutaneous and one preperitoneal

## Adaptor options

The Beta-Cap™ adaptor included in the packaging provides closure with standard CAPD transfer sets. Two-part titanium luer adapters are also available as an alternative. See page 17 for accessories options.

## Curl cath product highlights include:

- Curled tubing with numerous inflow/outflow holes
- Can be inserted percutaneously or surgically
- Made of translucent, medical-grade silicone rubber
- Radiopaque stripe
- Can be extended or repaired if necessary

## Simplifying with a kit

Curl cath catheters are also available in convenient catheter kits, which provide the necessary components for inserting the catheter by modified Seldinger technique.

# Curl cath catheters

## Curl cath catheters: 1 cuff

Catheter 8811313014 Curl Cath, 1 Preperitoneal Cuff, 57 cm 1/case

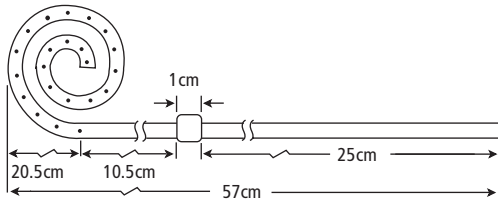

Catheter 8811313013 Curl Cath, 1 Preperitoneal Cuff, 60 cm 1/case

Kit 8817278010 Curl Cath, 1 Preperitoneal Cuff, 60 cm — catheter kit 5/case

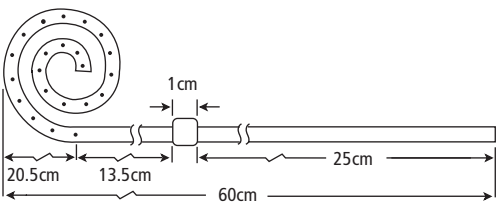

## Curl cath catheters: 2 cuffs

Catheter 8811313015 Curl cath, 2 cuff, 57 cm 1/case

Kit 8817278007 Curl cath, 2 cuff, 57 cm — catheter kit 5/case

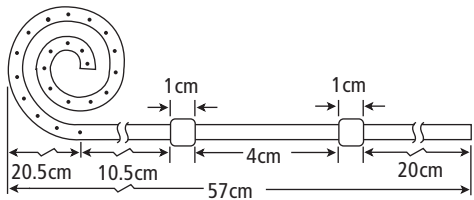

Catheter 8811313010 Curl cath, 2 cuff, 62 cm 1/case

Kit 8817278006 Curl cath, 2 cuff, 62 cm — catheter kit 5/case

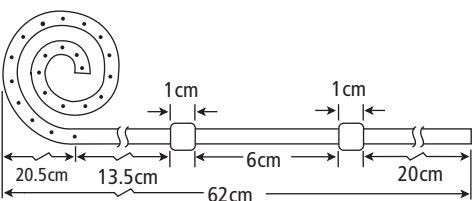

# Neonatal and pediatric peritoneal catheters

## Pediatric Tenckhoff catheters

Catheter 8812329002 Neonatal, Tenckhoff, 2 Cuff, 31 cm 1/case

Catheter 8888414227 Neonatal Tenckhoff, 2 cuff, 31 cm 1/case

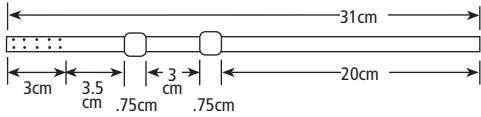

Catheter 8810890003 Pediatric Tenckhoff, 2 cuff, 37 cm 1/case

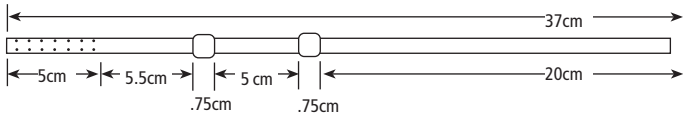

Catheter 8812329001 Neonatal Tenckhoff, 1 subcutaneous cuff, 31 cm 1/case

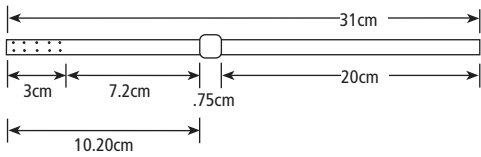

Catheter 8812321001 Pediatric Tenckhoff, 1 subcutaneous cuff, 37 cm 1/case

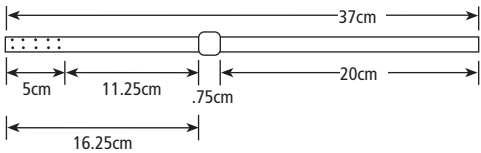

## Pediatric curl cath catheter

Catheter 8815677001 Pediatric curl cath, 1 preperitoneal cuff, 39 cm 1/case

Catheter 8888414508 Pediatric curl cath, 1 cuff, 39.25 cm 1/case

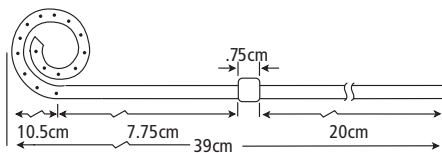

# Neonatal and pediatric peritoneal catheters

## Pediatric swan neck Tenckhoff catheter

Catheter 8888410506 Pediatric swan neck Tenckhoff, 2 cuff, left, 37.5 cm

1/case

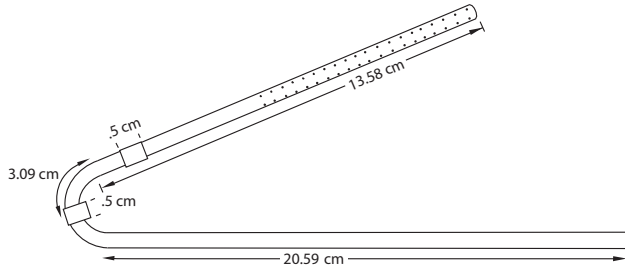

## Pediatric swan neck curl cath catheter

Catheter 8888413100 Pediatric Swan Neck curl cath, 2 Cuff, 38.9 cm

1/case

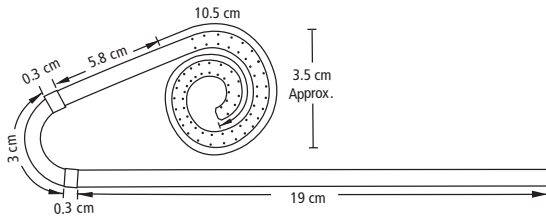

# Accessories: peritoneal catheters

---

## Peritoneal catheter straightening stylet

Straightening stylets help keep the catheter straight for maneuvering during insertion into the peritoneum. Stylets come in a variety of sizes and can be used on all catheter types. Nonsterile. Autoclavable.

8888415661 Catheter straightening stylet, 61 cm, for use with catheters 61 cm or shorter 1/case

## Atraumatic peritoneal tunneling stylet

This atraumatic tunneling stylet penetrates tissue. As the stylet dilates the tissue, the practitioner simultaneously pulls the catheter through the tunnel. Made of pliable stainless steel, it can be bent to create a customized, curved tunnel. The stylet is 5Fr X 23 cm (9"). Sterile. Single use only.

8817791001 Blunt tunneling stylet 5/case

## Faller tunneling trocar

This stylet is an alternative to the atraumatic tunneling stylet. It has a cutting edge on the portion leading into the tunnel and a barbed portion on the opposite end, which connects to the catheter. Sterile.

8888415679 Faller tunneling trocar 1/case

## Catheter stencils

These stencils provide a clear outline for the swan neck or swan neck Missouri catheters before implantation. Details include proper position on the abdominal wall and position of the silicone bead (Missouri). The stencil offers two choices of exit sites for the physician to select the location most appropriate for each patient. Each stencil can be turned over to select left-sided or right-sided placement. Nonsterile.

8888412304 Peritoneal Dialysis Catheter Stencil, Swan Neck Tenckhoff 1/case

8888412305 Ritus™ - Preoperative Peritoneal Dialysis Catheter Stencil (Embedding) 5/case

8888412312 Peritoneal Dialysis Catheter Stencil, Swan Neck Missouri 1/case

## Titanium adapter

An alternative to the Beta-Cap™\* adapter. Can be used on all of our peritoneal catheters. Sterile.

8888415604 Two part titanium luer adapter 1/case

## Medical grade silicone adhesive

This sterile adhesive is used to:

- Bond felt cuffs to the catheter
- Repair damaged catheters
- Extend the length of existing catheters

8810807001 Medical Grade Silicone Adhesive, Type A† 1/case

\*Must be ordered separately for any of the above uses.

# Accessories: peritoneal catheters

---

## Injection sealing caps

Used to close off the end of the catheter. Universal luer fitting. Sterile. Latex-free.

8813791001 Injection sealing cap 50/case

## Beta-Cap™\* adapter

These adapters form a tight closure with standard CAPD transfer sets, or connect to a sealing cap.

The Beta-Cap™\* adapter is made of Ultem™\* resin. Can be used with all of our peritoneal catheters. Sterile.

8814661001 Beta-Cap™\* adapter 25/case

## Beta-Cap™\* clamp

Used to clamp the peritoneal catheter tubing when not in use. Sterile.

8810805001 Beta-Cap™\* clamp 25/case

## Catheter extender

Provides 6 inches of silicone tubing with a titanium connector. Not attached. Sterile.

8888415612 Titanium Catheter Extender, Adult 1/case

## Peri-Patch™ repair kit

Replace the external portion of a damaged catheter with this repair kit. All components are sterile. Kits are double packaged; the inner package can be placed directly on a sterile field.

NOTE: To repair an indwelling catheter, there must be at least 3 cm undamaged tubing at the exit site.

### Sterile contents include:

- 15 cm silicone rubber catheter extension (2.6 mm ID, 4.9 mm OD) with double-barbed connector (1)
- Beta-Cap™\* adapter, cap and clamp (1)
- Glue mold (1)

8888285001 Peri-Patch™ Peritoneal Dialysis Catheter Repair Kit 1/case

NOTE: Compatible with medical grade adhesive (order #8810807001)

## Introducer set

Introducer sets are used when placing peritoneal catheters percutaneously.

8815544010 Pull Apart Introducer Set for Inserting Catheters and Pacing Leads, 16Fr 5/case

### Contents of the Introducer Set include:

- 16Fr pull-apart introducer (sheath/dilator)\* (1)
- 18 ga introducer needle (1)
- 12 mL syringe (1)
- J/Straight 0.038" guide wire (1)

\*Made with polytetrafluoroethylene (PTFE)

# Peritoneal dialysis catheters

## Indications for use

The peritoneal catheter is indicated for acute and chronic peritoneal dialysis. The peritoneal dialysis catheter may be inserted using open, laparoscopic or percutaneous surgical techniques.

## Warnings

Risks may include, but are not limited to: infection/peritonitis, abdominal distention or adhesions, compromised pulmonary function and decreased capacity of the peritoneal cavity.

## Contraindications

- Infected anterior abdominal wall.
- Patients with extensive intra-abdominal adhesions or malignancy.
- Conditions resulting in diaphragmatic tears or abdominal-chest communication.
- Unresolved peritonitis.
- Severe respiratory insufficiency: distending the abdomen with large amounts of dialysate may further compromise pulmonary function.
- Presence of ileus.
- The catheter is not intended for the Tenckhoff trocar method of insertion, nor is it meant to be used for any purpose other than indicated.
- Decreased capacity of peritoneal cavity.
- Lack of integrity of the abdominal wall.
- Inability to tolerate general anesthesia.
- When the catheter is used with the titanium accessories, this catheter would then be considered MR conditional.



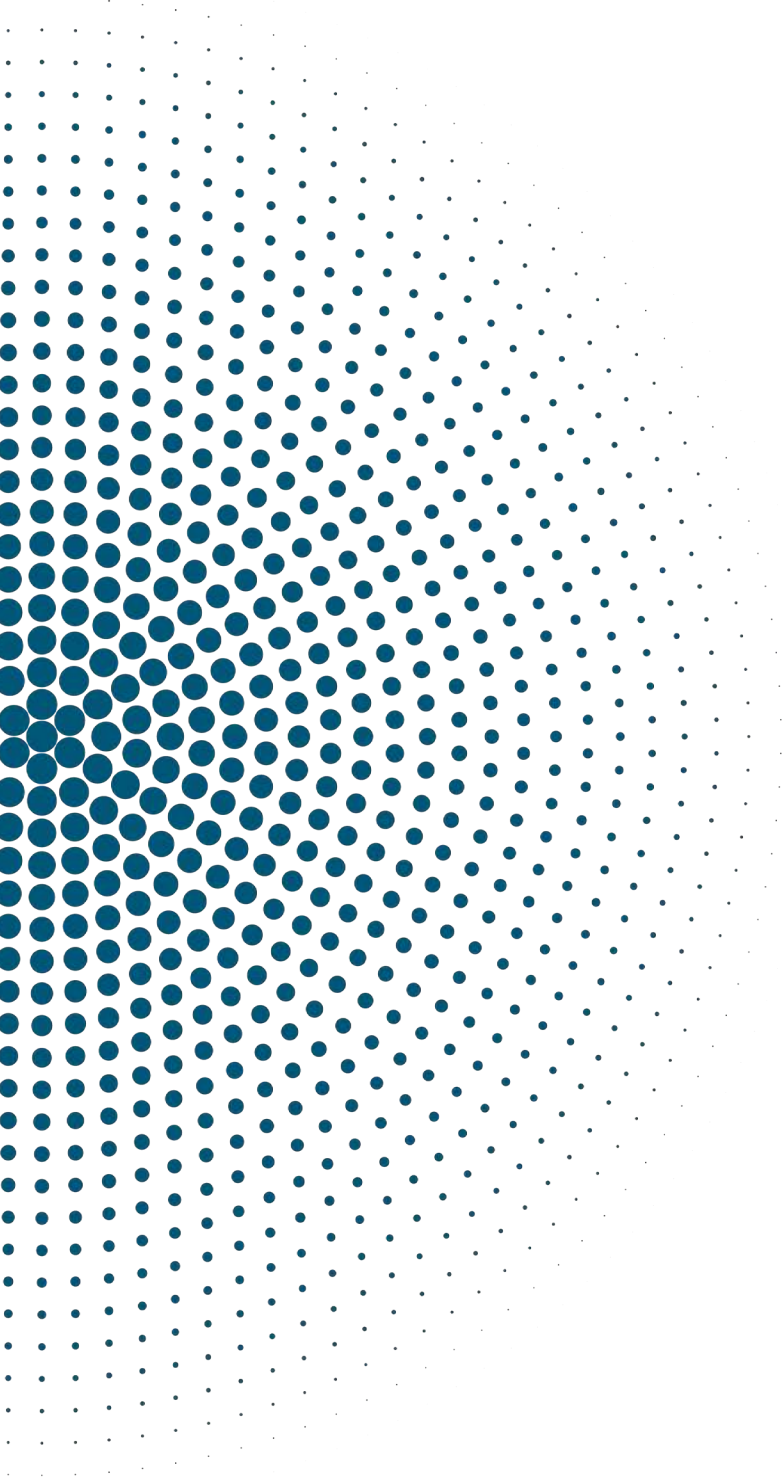

1. Al-Hwiesh A. Percutaneous Peritoneal Dialysis Catheter Insertion by a Nephrologist: A New, Simple, and Safe Technique. *Perit Dial Int*. 2014; Vol. 34(2): pp. 204–211.

©2024 Mozarc Medical Holding LLC. Mozarc, Mozarc Medical, the Mozarc Medical logos, and Empowering Patients. Enriching Lives are trademarks of Mozarc Medical. <sup>TM</sup>\* Third-party brands are trademarks of their respective owners. 10/2024 -US-RC-2200010 [WF#14577868]

710 Medtronic Parkway  
Minneapolis, MN 55432  
800.962.9888  
508.261.8000

[MozarcMedical.com](https://MozarcMedical.com)

**Mozarc**  
Empowering patients.  
Enriching lives. **medical**